

MULTICOLOM

Uitermate geschikt
voor lage
temperatuurinstallaties

Deze stalen meerkolommer presteert niet alleen uitstekend, hij mag er met z'n maximale hoogte van 2,5 meter, qua uiterlijk ook écht zijn. Met zijn 2, 3, 4, 5 of 6 kolommen is hij een perfecte aanvulling op uw interieur en wordt ervaren als behaaglijk gezelschap. DRL MULTICOLOM radiatoren kenmerken zich door een authentieke uitstraling en voelen zich in iedere ruimte thuis. Horizontaal, verticaal, op pootjes, gehoekt of gebogen en in de RAL of metaal kleur die u wenst. Hij kan altijd rekenen op een warm welkom in vooral oude herenhuizen en grachtenpanden, maar ook in kantoren en moderne interieurs is deze kolomradiator op z'n plek. De DRL stalen meerkolommer is een stalen perfectie die altijd in balans is met zijn omgeving.

De DRL MULTICOLOM is een magistra(a)le, volgens de modernste productietechnieken gefabriceerde meer-kolommer, met de nadruk op straal, of liever gezegd straling, want de MULTICOLOM is een topper in stralingswarmte. Door de ronde, gladde afwerking, is de DRL MULTICOLOM bovendien gemakkelijk schoon te houden. De karakteristieke verbindingen zijn een gevolg van geavanceerde lastechnieken. DRL MULTICOLOM: gestaalde perfectie in balans met zijn omgeving.



MULTICOLOM | 6 koloms



MULTICOLOM | 6 KOLOMS | Mat Zwart



MULTICOLOM 2 - 3 - 4 - 5 of 6 koloms Lange levensduur dankzij hoge kwaliteit

- Verkrijgbaar tot maar liefst 2500 mm hoog en 3244 mm lang
- Hoogte maten (A) tussen 207 en 2500 mm, 3 t/m 70 elementen
- Lengte maten vanaf 162 t/m 3244 mm, telkens met 46 mm oplopend
- Leverbaar als wandmodel of vloermodel op pootjes
- Hoge warmte afgifte dus uitermate geschikt voor lage temperatuurinstallaties
- Door grote oppervlakte straalt de kolomradiator veel warmte uit
- Diverse aansluittoepassingen mogelijk
- Duurzaam en energiebesparend
- Zeer lange levensduur dankzij hoge kwaliteit
- Authentieke uitstraling
- Gemakkelijk schoon te houden



< **MULTICOLOM** | 4 koloms | RAL 9010

> **MULTICOLOM** | Ondervoetjes | Rough Black



DRL KOLOM RADIATOR

MULTICOLOM COMFORT

Warmte en zitcomfort

Hoe koud of guur het buiten ook is, binnen staat de radiator aan en is het lekker warm. Kan het nóg gerieflijker? Ja! Wat dacht u van een warmtebron waarop u kunt zitten? De DRL MULTICOLOM COMFORT is een functionele, maar ook mooie designradiator die ieder vertrek verfraait. De horizontale buizen van dit eigentijdse model zijn vanaf de grond gestapeld. Aan de bovenzijde is een zitje geplaatst van 25 millimeter dik massief hout, waardoor een robuust en toch uiterst charmant bankje ontstaat. Ideaal voor ruimtes waarin u met meerdere mensen bij elkaar bent, zoals een wachtkamer, kleedkamer, ontvangstruimte of hal. De DRL MULTICOLOM COMFORT is een unieke eyecatcher met allure en uitstraling.



< MULTICOLOM | COMFORT | < RAL 7030

DRL MULTICOLOM KOLOM RADIATOR



MULTICOLOM COMFORT Multifunctioneel bankje

KENMERKEN:

- Hoogte maten (A) 350, 650, 396 en 442 mm, 4 t/m 6 elementen
- Lengte maten vanaf 650 t/m 2650 mm
- Dieptemaat 290 mm
- Zitje in masief hout 25 mm
- Hoge warmte afgifte dus uitermate geschikt voor lage temperatuurinstallaties
- Door grote oppervlakte straalt de kolomradiator veel warmte uit
- Duurzaam en energiebesparend
- Zeer lange levensduur dankzij hoge kwaliteit
- Authentieke uitstraling
- Gemakkelijk schoon te houden

< MULTICOLOM | COMFORT |
Verkrijgbaar in verschillende lengtematen en hoogtes



DRL KOLOM RADIATOREN

MULTICOLOM 2-3-4-5-6 KOLOMS | MULTICOLOM COMFORT

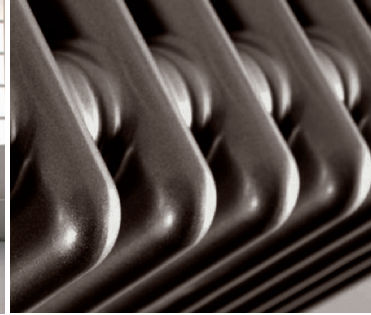

Deze stalen meerkolommer presteert niet alleen uitstekend, hij mag er met z'n maximale hoogte van 2,5 meter, qua uiterlijk ook écht zijn. Met zijn 2, 3, 4, 5 of 6 kolommen is hij een perfecte aanvulling op uw interieur en wordt ervaren als behaaglijk gezelschap.

DRL MULTICOLOM radiatoren kenmerken zich door een authentieke uitstraling en voelen zich in iedere ruimte thuis. Horizontaal, verticaal, op pootjes en in iedere RAL of metaal kleur die u wenst. Hij kan altijd rekenen op een warm welkom in vooral oude herenhuizen en grachtenpanden, maar ook in kantoren en moderne interieurs is deze kolomradiator op z'n plek. Deze geliefde radiator weet als geen ander hoe hij met zijn repetitieve lijnenpatronen een strakke vormgeving kan onderstrepen. Doordat de stalen buizen van deze ledenradiatoren glad zijn en dus gemakkelijk schoon te houden, loopt u deze tevens vaak tegen het lijf op plekken waar hygiëne extra belangrijk is zoals in ziekenhuizen, scholen en kinderdagverblijven. Kortom: De DRL stalen meerkolommer is een stalen perfectie die altijd in balans is met zijn omgeving.

De DRL MULTICOLOM radiatoren zijn tevens verkrijgbaar als COMFORT uitvoering:

MULTICOLOM COMFORT: Buisbank radiator met aan de bovenzijde een zitje van massief hout.



SPECIFICATIES:

- **Materiaal:** Buizen in gepoedercoat staal ø 25 mm
Model Comfort: Bankje met massief houten zitting 25 mm D
Muurbeugel en muurconsoles, bij prijs inbegrepen.
- **Montage:**
3 t/m 20 elementen: 2 muurbeugels en 2 muurconsoles
21 t/m 40 elementen: 3 muurbeugels en 3 muurconsoles
41 t/m 60 elementen: 4 muurbeugels en 4 muurconsoles
61 t/m 70 elementen: 5 muurbeugels en 5 muurconsoles
In Watt bij 75/65/20 | Conform EN 442
- **Afgifte:** Afgeperst op 10,5 bar. Maximale werkdruk van 8 bar bij 95°C.
- **Werkdruk:** Tussen 54 en 8750 Watt
- **Vermogens:** STANDAARD: 1 t/m 4 (4 x ½" binnendraad) (geen meerprijs)
SPECIAAL: 5 t/m 8 (geen meerprijs)
Keerplaatje gelijktijdig bestellen moet fabrieksmatig gemonteerd worden!
- **Aansluitingen:** COMPACT: 9 t/m 18 (h.o.h. 50 mm ½" binnendraad)
VENTIEL COMPACT: 20, 21, 22 en 23 (h.o.h. 50 mm ½" binnendraad)
Onderzetvoetje RAL 9010, 120 mm H, incl. afstandhouder los verkrijgbaar
Wit RAL 9010 of 9016
Leverbaar tegen een meerprijs in alle RAL- en diverse metaalkleuren (zie kleurenkaarten achterin)
Gepoedercoat met ecologisch poeder
Bekijk ons aanbod DRL Design KRANENSETS
- **Onderzetvoetje:** 5 jaar fabrieksgarantie
- **Kleuren:** Met www.snelselect.nl kunt u snel en eenvoudig selecties maken, calculeren en bestelinformatie genereren voor uw groothandel
- **Lakproces**
- **Kranensets:**
- **Garantie:**
- **Selecties maken:**

KENMERKEN MULTICOLOM:

- Hoge warmte afgifte dus uitermate geschikt voor lage temperatuurinstallaties
- Door grote oppervlakte straalt de kolomradiator veel warmte uit
- Duurzaam en energiebesparend
- Zeer lange levensduur dankzij hoge kwaliteit
- Authentieke uitstraling
- Gemakkelijk schoon te houden

KENMERKEN MULTICOLOM 2-3-4-5-6 KOLOMS:

- Verkrijgbaar tot maar liefst 2500 mm hoog en 3244 mm lang
- Hoogte maten (A) tussen 207 en 2500 mm, 3 t/m 70 elementen
- Lengte maten vanaf 162 t/m 3244 mm, telkens met 46 mm olopend
- Leverbaar als wandmodel of vloermodel op pootjes
- Diverse aansluittoepassingen mogelijk

KENMERKEN MULTICOLOM COMFORT

- Hoogte maten (A) 350, 650, 396 en 442 mm, 4 t/m 6 elementen
- Lengte maten vanaf 650 t/m 2650 mm
- Leverbaar als Comfort model, bankje met massief houten zitting 25 mm D

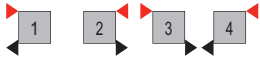
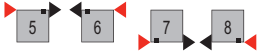

STANDAARD AANSLUITINGEN 1 T/M 4:**SPECIALE AANSLUITINGEN 5 T/M 8:**

Keerplaatje wordt fabrieksmatig voorge monteerd

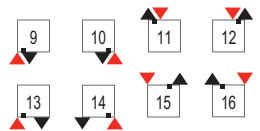
COMPACT AANSLUITINGEN 9 T/M 18:
(Meerprijs)

18 Middenonderaansluiting 18 is alleen toepasbaar bij een even aantal elementen

VENTIEL COMPACT AANSLUITINGEN 20 T/M 23:
(Meerprijs)

Completo M 30 x 1,5 mm thermostatisch regelventiel (aansluitingen h.o.h. 50 mm 1/2" binnendraad)

Alle aansluitingen zijn uitgevoerd in 1/2" binnendraad.

LEGENDA

- aanvoer
- retour
- aansluitcode
- keerplaatje



MULTICOLOM met stalen ondervoetjes

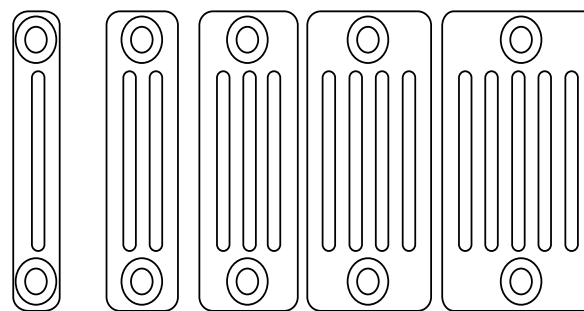
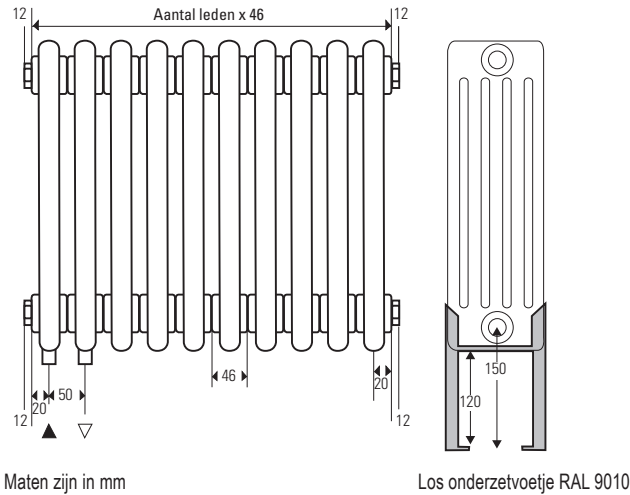

66 mm 2 koloms 107 mm 3 koloms 148 mm 4 koloms 189 mm 5 koloms 230 mm 6 koloms

De Middenonder aansluiting 18, 22 en 23 kan alleen worden toegepast op radiatoren welke binnen een bepaalde lengtemaat, hoogte en/of capaciteit criterium vallen. Voor snelle selectie van radiatoren met middenonder aansluiting 18, 22 en 23 kunt u ons selectieprogramma www.sneselect.nl raadplegen.

Wanneer u een radiator selecteert die buiten deze selectiecriteria valt kan het selectie programma deze radiator niet selecteren en is dus de levering hiervan niet mogelijk.

DRL MULTICOLOM radiatoren worden af fabriek geleverd in blokken van maximaal 40 elementen. Indien u bij bestelling van radiatoren langer dan 40 elementen niets aangeeft, koppelen wij de blokken kosteloos (dus de radiator in 1 stuk).

U dient er rekening mee te houden dat op de plaats waar de radiatoren gekoppeld zijn de pakkingring altijd zichtbaar zal blijven.

MUURBEUGELS EN MUURCONSOLES | STANDAARD BIJ PRIJS INBEGREPEN

- 3 t/m 20 elementen: 2 muurbeugels en 2 muurconsoles
- 21 t/m 40 elementen: 3 muurbeugels en 3 muurconsoles
- 41 t/m 60 elementen: 4 muurbeugels en 4 muurconsoles
- 61 t/m 70 elementen: 5 muurbeugels en 5 muurconsoles



MULTICOLOM 2 koloms MULTICOLOM 3 koloms MULTICOLOM 4 koloms MULTICOLOM 5 koloms MULTICOLOM 6 koloms

DRL MULTICOLOM 2 KOLOMS

KOLOM RADIATOR

HOOGTE		207	300	400	500	600	750	900	1000	1200	1500	1800	2000	2200	2500
Watt/e175/65/20		18	26	33	40	47	58	68	75	90	111	134	150	166	191
LEDEN		AFSTANDHOUDERS EN MUURCONSOLES BIJ DE PRIJS INBEGREPEN													
AANTAL	LENGTE	143	300	172	500	192	750	212	1000	244	1500	1800	2000	2200	2500
3	162														
		54	78	99	120	141	174	204	225	270	333	402	450	498	573
4	208														
		72	104	132	160	188	232	272	300	360	444	536	600	664	764
5	254														
		90	130	165	200	235	290	340	375	450	555	670	750	830	955
6	300														
		108	156	198	240	282	348	408	450	540	666	804	900	996	1146
7	346														
		126	182	231	280	329	406	476	525	630	777	938	1050	1162	1337
8	392														
		144	208	264	320	376	464	544	600	720	888	1072	1200	1328	1528
9	438														
		162	234	297	360	423	522	612	675	810	999	1206	1350	1494	1719
10	484														
		180	260	330	400	470	580	680	750	900	1110	1340	1500	1660	1910
11	530														
		198	286	363	440	517	638	748	825	990	1221	1474	1650	1826	2101
12	576														
		216	312	396	480	564	696	816	900	1080	1332	1608	1800	1992	2292
13	622														
		234	338	429	520	611	754	884	975	1170	1443	1742	1950	2158	2483
14	668														
		252	364	462	560	658	812	952	1050	1260	1554	1876	2100	2324	2674
15	714														
		270	390	495	600	705	870	1020	1125	1350	1665	2010	2250	2490	2865
16	760														
		288	416	528	640	752	928	1088	1200	1440	1776	2144	2400	2656	3056
18	852														
		324	468	594	720	846	1044	1224	1350	1620	1998				
20	944														
		360	520	660	800	940	1160	1360	1500	1800	2220				
22	1036														
		396	572	726	880	1034	1276	1496	1650	1980	2442				
24	1128														
		432	624	792	960	1128	1392	1632	1800	2160	2664				
26	1220														
		468	676	858	1040	1222	1508	1768	1950	2340	2886				
28	1312														
		504	728	924	1120	1316	1624	1904	2100	2520	3108				
30	1404														
		540	780	990	1200	1410	1740	2040	2250	2700	3330				
32	1496														
		576	832	1056	1280	1504	1856	2176	2400						
34	1588														
		612	884	1122	1360	1598	1972	2312	2550						
36	1680														
		648	936	1188	1440	1692	2088	2448	2700						
38	1772														
		684	988	1254	1520	1786	2204	2584	2850						
40	1864														
		720	1040	1320	1600	1880	2320	2720	3000						
42	1956														
		756	1092	1386	1680	1974	2436								
44	2048														
		792	1144	1452	1760	2068	2552								
46	2140														
		828	1196	1518	1840	2162	2668								
48	2232														
		864	1248	1584	1920	2256	2784								
50	2324														
		900	1300	1650	2000	2350	2900								
52	2416														
		936	1352	1716	2080	2444									
54	2508														
		972	1404	1782	2160	2538									
56	2600														
		1008	1456	1848	2240	2632									
58	2692														
		1044	1508	1914	2320	2726									
60	2784														
		1080	1560	1980	2400	2820									
62	2876														
		1116	1612	2046	2480	2914									
64	2968														
		1152	1664	2112	2560	3008									
66	3060														
		1188	1716	2178	2640	3102									
68	3152														
		1224	1768	2244	2720	3196									
70	3244														
		1260	1820	2310	2800	3290									



Standaard inbegrepen:
Muurbeugel en muurconsole

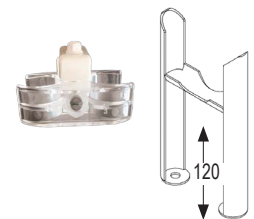

Optioneel: Bovenvasthouder
en stalen ondervoetje

DRL MULTICOLOM radiatoren worden af fabriek geleverd in blokken van max. 40 elementen. Indien u bij bestelling van radiatoren langer dan 40 elementen niets aangeeft, koppelen wij de blokken kosteloos (dus de radiator in 1 stuk). U dient er rekening mee te houden dat op de plaats waar de radiatoren gekoppeld zijn, de pakkingring altijd zichtbaar zal blijven.

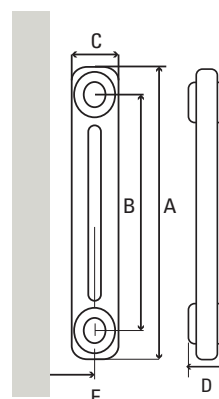

DRL MULTICOLOM 2 KOLOMS

MODEL	A (mm)	B (mm)	C (mm)	D (mm)	E (mm)	Gewicht (kg)	Inhoud (l)
207	207	151	66	46	73-93	0,35	0,29
300	300	244	66	46	73-93	0,49	0,37
400	400	344	66	46	73-93	0,63	0,45
500	500	444	66	46	73-93	0,77	0,53
600	600	544	66	46	73-93	0,91	0,61
750	750	694	66	46	73-93	1,12	0,73
900	900	844	66	46	73-93	1,33	0,85
1000	1000	944	66	46	73-93	1,48	0,93
1200	1200	1144	66	46	73-93	1,76	1,09
1500	1500	1444	66	46	73-93	2,18	1,33
1800	1800	1744	66	46	73-93	2,60	1,58
2000	2000	1944	66	46	73-93	2,89	1,74
2200	2200	2144	66	46	73-93	3,17	1,90
2500	2500	2444	66	46	73-93	3,59	2,14

DRL MULTICOLOM 3 KOLOMS

KOLOM RADIATOR

HOOGTE		207	300	400	500	600	750	900	1000	1200	1500	1800	2000	2200	2500
Watt/el75/65/20		25	35	45	55	65	80	95	104	124	152	180	199	218	246
LEDEN		AFSTANDHOUDERS EN MUURCONSOLES BIJ DE PRIJS INBEGREPEN													
AANTAL	LENGTE	207	300	400	500	600	750	900	1000	1200	1500	1800	2000	2200	2500
3	162														
		75	105	135	165	195	240	285	312	372	456	540	597	654	738
4	208														
		100	140	180	220	260	320	380	416	496	608	720	796	872	984
5	254														
		125	175	225	275	325	400	475	520	620	760	900	995	1090	1230
6	300														
		150	210	270	330	390	480	570	624	744	912	1080	1194	1308	1476
7	346														
		175	245	315	385	455	560	665	728	868	1064	1260	1393	1526	1722
8	392														
		200	280	360	440	520	640	760	832	992	1216	1440	1592	1744	1968
9	438														
		225	315	405	495	585	720	855	936	1116	1368	1620	1791	1962	2214
10	484														
		250	350	450	550	650	800	950	1040	1240	1520	1800	1990	2180	2460
11	530														
		275	385	495	605	715	880	1045	1144	1364	1672	1980	2189	2398	2706
12	576														
		300	420	540	660	780	960	1140	1248	1488	1824	2160	2388	2616	2952
13	622														
		325	455	585	715	845	1040	1235	1352	1612	1976	2340	2587	2834	3198
14	668														
		350	490	630	770	910	1120	1330	1456	1736	2128	2520	2786	3052	3444
15	714														
		375	525	675	825	975	1200	1425	1560	1860	2280	2700	2985	3270	3690
16	760														
		400	560	720	880	1040	1280	1520	1664	1984	2432	2880	3184	3488	3936
18	852														
		450	630	810	990	1170	1440	1710	1872	2232	2736				
20	944														
		500	700	900	1100	1300	1600	1900	2080	2480	3040				
22	1036														
		550	770	990	1210	1430	1760	2090	2288	2728	3344				
24	1128														
		600	840	1080	1320	1560	1920	2280	2496	2976	3648				
26	1220														
		650	910	1170	1430	1690	2080	2470	2704	3224	3952				
28	1312														
		700	980	1260	1540	1820	2240	2660	2912	3472	4256				
30	1404														
		750	1050	1350	1650	1950	2400	2850	3120	3720	4560				
32	1496														
		800	1120	1440	1760	2080	2560	3040	3328						
34	1588														
		850	1190	1530	1870	2210	2720	3230	3536						
36	1680														
		900	1260	1620	1980	2340	2880	3420	3744						
38	1772														
		950	1330	1710	2090	2470	3040	3610	3952						
40	1864														
		1000	1400	1800	2200	2600	3200	3800	4160						
42	1956														
		1050	1470	1890	2310	2730	3360								
44	2048														
		1100	1540	1980	2420	2860	3520								
46	2140														
		1150	1610	2070	2530	2990	3680								
48	2232														
		1200	1680	2160	2640	3120	3840								
50	2324														
		1250	1750	2250	2750	3250	4000								
52	2416														
		1300	1820	2340	2860	3380									
54	2508														
		1350	1890	2430	2970	3510									
56	2600														
		1400	1960	2520	3080	3640									
58	2692														
		1450	2030	2610	3190	3770									
60	2784														
		1500	2100	2700	3300	3900									
62	2876														
		1550	2170	2790	3410	4030									
64	2968														
		1600	2240	2880	3520	4160									
66	3060														
		1650	2310	2970	3630	4290									
68	3152														
		1700	2380	3060	3740	4420									
70	3244														
		1750	2450	3150	3850	4550									



Standaard inbegrepen:
Muurbeugel en muurconsole

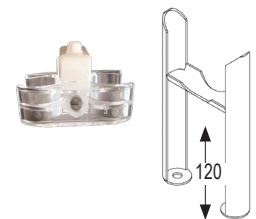

Optioneel: Muurbeugel en
stalen onderzetvoetje

DRL MULTICOLOM radiatoren worden af fabriek geleverd in blokken van max. 40 elementen. Indien u bij bestelling van radiatoren langer dan 40 elementen niets aangeeft, koppelen wij de blokken kosteloos (dus de radiator in 1 stuk). U dient er rekening mee te houden dat op de plaats waar de radiatoren gekoppeld zijn, de pakkingring altijd zichtbaar zal blijven.

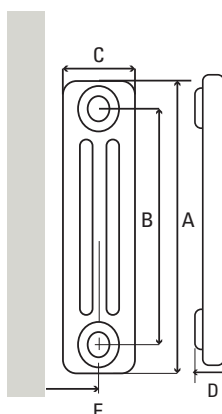

DRL MULTICOLOM 3 KOLOMS							
MODEL	A (mm)	B (mm)	C (mm)	D (mm)	E (mm)	Gewicht (kg)	Inhoud (l)
207	207	151	107	46	73-93	0,53	0,42
300	300	244	107	46	73-93	0,74	0,54
400	400	344	107	46	73-93	0,95	0,66
500	500	444	107	46	73-93	1,16	0,79
600	600	544	107	46	73-93	1,37	0,91
750	750	694	107	46	73-93	1,69	1,09
900	900	844	107	46	73-93	2,01	1,27
1000	1000	944	107	46	73-93	2,22	1,39
1200	1200	1144	107	46	73-93	2,64	1,63
1500	1500	1444	107	46	73-93	3,28	1,99
1800	1800	1744	107	46	73-93	3,91	2,35
2000	2000	1944	107	46	73-93	4,33	2,59
2200	2200	2144	107	46	73-93	4,76	2,83
2500	2500	2444	107	46	73-93	5,39	3,19

DRL MULTICOLOM 4 KOLOMS

KOLOM RADIATOR

HOOGTE		207	300	400	500	600	750	900	1000	1200	1500	1800	2000	2200	2500
Watt/e175/65/20		25	35	45	55	65	80	95	104	124	152	180	199	218	246
LEDEN		AFSTANDHOUDERS EN MUURCONSOLES BIJ DE PRIJS INBEGREPEN													
AANTAL	LENGTE	207	300	400	500	600	750	900	1000	1200	1500	1800	2000	2200	2500
3	162														
		96	141	180	216	255	309	363	399	468	573	681	750	822	930
4	208														
		128	188	240	288	340	412	484	532	624	764	908	1000	1096	1240
5	254														
		160	235	300	360	425	515	605	665	780	955	1135	1250	1370	1550
6	300														
		192	282	360	432	510	618	726	798	936	1146	1362	1500	1644	1860
7	346														
		224	329	420	504	595	721	847	931	1092	1337	1589	1750	1918	2170
8	392														
		256	376	480	576	680	824	968	1064	1248	1528	1816	2000	2192	2480
9	438														
		288	423	540	648	765	927	1089	1197	1404	1719	2043	2250	2466	2790
10	484														
		320	470	600	720	850	1030	1210	1330	1560	1910	2270	2500	2740	3100
11	530														
		352	517	660	792	935	1133	1331	1463	1716	2101	2497	2750	3014	3410
12	576														
		384	564	720	864	1020	1236	1452	1596	1872	2292	2724	3000	3288	3720
13	622														
		416	611	780	936	1105	1339	1573	1729	2028	2483	2951	3250	3562	4030
14	668														
		448	658	840	1008	1190	1442	1694	1862	2184	2674	3178	3500	3836	4340
15	714														
		480	705	900	1080	1275	1545	1815	1995	2340	2865	3405	3750	4110	4650
16	760														
		512	752	960	1152	1360	1648	1936	2128	2496	3056	3632	4000	4384	4960
18	852														
		576	846	1080	1296	1530	1854	2178	2394	2808	3438				
20	944														
		640	940	1200	1440	1700	2060	2420	2660	3120	3820				
22	1036														
		704	1034	1320	1584	1870	2266	2662	2926	3432	4202				
24	1128														
		768	1128	1440	1728	2040	2472	2904	3192	3744	4584				
26	1220														
		832	1222	1560	1872	2210	2678	3146	3458	4056	4966				
28	1312														
		896	1316	1680	2016	2380	2884	3388	3724	4368	5348				
30	1404														
		960	1410	1800	2160	2550	3090	3630	3990	4680	5730				
32	1496														
		1024	1504	1920	2304	2720	3296	3872	4256						
34	1588														
		1088	1598	2040	2448	2890	3502	4114	4522						
36	1680														
		1152	1692	2160	2592	3060	3708	4356	4788						
38	1772														
		1216	1786	2280	2736	3230	3914	4598	5054						
40	1864														
		1280	1880	2400	2880	3400	4120	4840	5320						
42	1956														
		1344	1974	2520	3024	3570	4326								
44	2048														
		1408	2068	2640	3168	3740	4532								
46	2140														
		1472	2162	2760	3312	3910	4738								
48	2232														
		1536	2256	2880	3456	4080	4944								
50	2324														
		1600	2350	3000	3600	4250	5150								
52	2416														
		1664	2444	3120	3744	4420									
54	2508														
		1728	2538	3240	3888	4590									
56	2600														
		1792	2632	3360	4032	4760									
58	2692														
		1856	2726	3480	4176	4930									
60	2784														
		1920	2820	3600	4320	5100									
62	2876														
		1984	2914	3720	4464	5270									
64	2968														
		2048	3008	3840	4608	5440									
66	3060														
		2112	3102	3960	4752	5610									
68	3152														
		2176	3196	4080	4896	5780									
70	3244														
		2240	3290	4200	5040	5950									



Standaard inbegrepen:
Muurbeugel en muurconsole

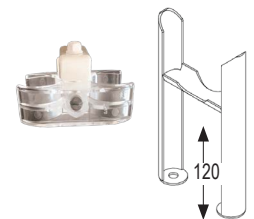

Optioneel: Afstandhouder en
stalen ondervoetje

DRL MULTICOLOM radiatoren worden af fabriek geleverd in blokken van max. 40 elementen. Indien u bij bestelling van radiatoren langer dan 40 elementen niets aangeeft, koppelen wij de blokken kosteloos (dus de radiator in 1 stuk). U dient er rekening mee te houden dat op de plaats waar de radiatoren gekoppeld zijn, de pakkingring altijd zichtbaar zal blijven.

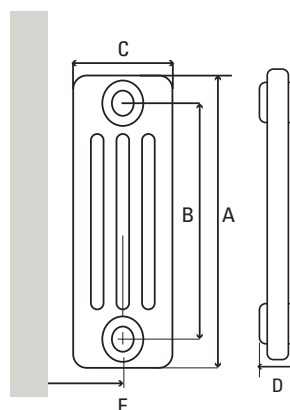

DRL MULTICOLOM 4 KOLOMS

MODEL	A (mm)	B (mm)	C (mm)	D (mm)	E (mm)	Gewicht (kg)	Inhoud (l)
207	207	151	148	46	114-134	0,71	0,56
300	300	244	148	46	114-134	0,99	0,72
400	400	344	148	46	114-134	1,27	0,88
500	500	444	148	46	114-134	1,55	1,04
600	600	544	148	46	114-134	1,84	1,20
750	750	694	148	46	114-134	2,26	1,44
900	900	844	148	46	114-134	2,68	1,68
1000	1000	944	148	46	114-134	2,96	1,84
1200	1200	1144	148	46	114-134	3,53	2,17
1500	1500	144	148	46	114-134	4,37	2,65
1800	1800	1744	148	46	114-134	5,22	3,13
2000	2000	1944	148	46	114-134	5,78	3,45
2200	2200	2144	148	46	114-134	6,35	3,77
2500	2500	2444	148	46	114-134	7,19	4,25

DRL MULTICOLOM 5 KOLOMS

KOLOM RADIATOR

HOOGTE		207	300	400	500	600	750	900	1000	1200	1500	1800	2000	2200	2500
Watt/el75/65/20		40	57	72	88	103	125	146	161	189	230	272	299	326	367
LEDEN		AFSTANDHOUDERS EN MUURCONSOLES BIJ DE PRIJS INBEGREPEN													
AANTAL	LENGTE	207	300	400	500	600	750	900	1000	1200	1500	1800	2000	2200	2500
3	162														
		120	171	216	264	309	375	438	483	567	690	816	897	978	1101
4	208														
		160	228	288	352	412	500	584	644	756	920	1088	1196	1304	1468
5	254														
		200	285	360	440	515	625	730	805	945	1150	1360	1495	1630	1835
6	300														
		240	342	432	528	618	750	876	966	1134	1380	1632	1794	1956	2202
7	346														
		280	399	504	616	721	875	1022	1127	1323	1610	1904	2093	2282	2569
8	392														
		320	456	576	704	824	1000	1168	1288	1512	1840	2176	2392	2608	2936
9	438														
		360	513	648	792	927	1125	1314	1449	1701	2070	2448	2691	2934	3303
10	484														
		400	570	720	880	1030	1250	1460	1610	1890	2300	2720	2990	3260	3670
11	530														
		440	627	792	968	1133	1375	1606	1771	2079	2530	2992	3289	3586	4037
12	576														
		480	684	864	1056	1236	1500	1752	1932	2268	2760	3264	3588	3912	4404
13	622														
		520	741	936	1144	1339	1625	1898	2093	2457	2990	3536	3887	4238	4771
14	668														
		560	798	1008	1232	1442	1750	2044	2254	2646	3220	3808	4186	4564	5138
15	714														
		600	855	1080	1320	1545	1875	2190	2415	2835	3450	4080	4485	4890	5505
16	760														
		640	912	1152	1408	1648	2000	2336	2576	3024	3680	4352	4784	5216	5872
18	852														
		720	1026	1296	1584	1854	2250	2628	2898	3402	4140				
20	944														
		800	1140	1440	1760	2060	2500	2920	3220	3780	4600				
22	1036														
		880	1254	1584	1936	2266	2750	3212	3542	4158	5060				
24	1128														
		960	1368	1728	2112	2472	3000	3504	3864	4536	5520				
26	1220														
		1040	1482	1872	2288	2678	3250	3796	4186	4914	5980				
28	1312														
		1120	1596	2016	2464	2884	3500	4088	4508	5292	6440				
30	1404														
		1200	1710	2160	2640	3090	3750	4380	4830	5670	6900				
32	1496														
		1280	1824	2304	2816	3296	4000	4672	5152						
34	1588														
		1360	1938	2448	2992	3502	4250	4964	5474						
36	1680														
		1440	2052	2592	3168	3708	4500	5256	5796						
38	1772														
		1520	2166	2736	3344	3914	4750	5548	6118						
40	1864														
		1600	2280	2880	3520	4120	5000	5840	6440						
42	1956														
		1680	2394	3024	3696	4326	5250								
44	2048														
		1760	2508	3168	3872	4532	5500								
46	2140														
		1840	2622	3312	4048	4738	5750								
48	2232														
		1920	2736	3456	4224	4944	6000								
50	2324														
		2000	2850	3600	4400	5150	6250								
52	2416														
		2080	2964	3744	4576	5356									
54	2508														
		2160	3078	3888	4752	5562									
56	2600														
		2240	3192	4032	4928	5768									
58	2692														
		2320	3306	4176	5104	5974									
60	2784														
		2400	3420	4320	5280	6180									
62	2876														
		2480	3534	4464	5456	6386									
64	2968														
		2560	3648	4608	5632	6592									
66	3060														
		2640	3762	4752	5808	6798									
68	3152														
		2720	3876	4896	5984	7004									
70	3244														
		2800	3990	5040	6160	7210									



Standaard inbegrepen:
Bovenvasthouder en muurconsole

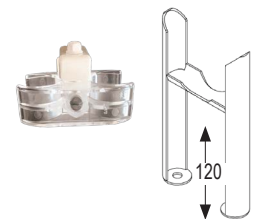

DRL MULTICOLOM radiatoren worden af fabriek geleverd in blokken van max. 40 elementen. Indien u bij bestelling van radiatoren langer dan 40 elementen niets aangeeft, koppelen wij de blokken kosteloos (dus de radiator in 1 stuk). U dient er rekening mee te houden dat op de plaats waar de radiatoren gekoppeld zijn, de pakkingring altijd zichtbaar zal blijven.

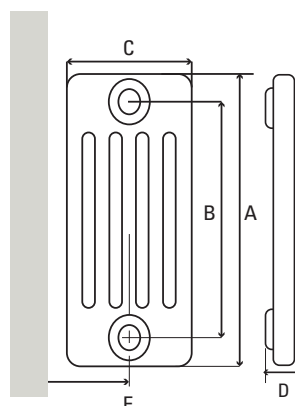

DRL MULTICOLOM 5 KOLOMS							
MODEL	A (mm)	B (mm)	C (mm)	D (mm)	E (mm)	Gewicht (kg)	Inhoud (l)
207	207	151	189	46	155-175	0,89	0,70
300	300	244	189	46	155-175	1,24	0,90
400	400	344	189	46	155-175	1,59	1,10
500	500	444	189	46	155-175	1,95	1,30
600	600	544	189	46	155-175	2,30	1,50
750	750	694	189	46	155-175	2,83	1,80
900	900	844	189	46	155-175	3,36	2,10
1000	1000	944	189	46	155-175	3,71	2,30
1200	1200	1144	189	46	155-175	4,41	2,70
1500	1500	144	189	46	155-175	5,47	3,30
1800	1800	1744	189	46	155-175	6,53	3,91
2000	2000	1944	189	46	155-175	7,26	4,31
2200	2200	2144	189	46	155-175	7,94	4,71
2500	2500	2444	189	46	155-175	9,00	5,31

DRL MULTICOLOM 6 KOLOMS

KOLOM RADIATOR

HOOGTE		207	300	400	500	600	750	900	1000	1200	1500	1800	2000	2200	2500
Watt/e175/65/20		49	68	87	106	125	151	176	193	224	270	313	340	366	403
LEDEN		AFSTANDHOUDERS EN MUURCONSOLES BIJ DE PRIJS INBEGREPEN													
AANTAL	LENGTE														
3	162														
		147	204	261	318	375	453	528	579	672	810	939	1020	1098	1209
4	208														
		196	272	348	424	500	604	704	772	896	1080	1252	1360	1464	1612
5	254														
		245	340	435	530	625	755	880	965	1120	1350	1565	1700	1830	2015
6	300														
		294	408	522	636	750	906	1056	1158	1344	1620	1878	2040	2196	2418
7	346														
		343	476	609	742	875	1057	1232	1351	1568	1890	2191	2380	2562	2821
8	392														
		392	544	696	848	1000	1208	1408	1544	1792	2160	2504	2720	2928	3224
9	438														
		441	612	783	954	1125	1359	1584	1737	2016	2430	2817	3060	3294	3627
10	484														
		490	680	870	1060	1250	1510	1760	1930	2240	2700	3130	3400	3660	4030
11	530														
		539	748	957	1166	1375	1661	1936	2123	2464	2970	3443	3740	4026	4433
12	576														
		588	816	1044	1272	1500	1812	2112	2316	2688	3240	3756	4080	4392	4836
13	622														
		637	884	1131	1378	1625	1963	2288	2509	2912	3510	4069	4420	4758	5239
14	668														
		686	952	1218	1484	1750	2114	2464	2702	3136	3780	4382	4760	5124	5642
15	714														
		735	1020	1305	1590	1875	2265	2640	2895	3360	4050	4695	5100	5490	6045
16	760														
		784	1088	1392	1696	2000	2416	2816	3088	3584	4320	5008	5440	5856	6448
18	852														
		882	1224	1566	1908	2250	2718	3168	3474	4032	4860				
20	944														
		980	1360	1740	2120	2500	3020	3520	3860	4480	5400				
22	1036														
		1078	1496	1914	2332	2750	3322	3872	4246	4928	5940				
24	1128														
		1176	1632	2088	2544	3000	3624	4224	4632	5376	6480				
26	1220														
		1274	1768	2262	2756	3250	3926	4576	5018	5824	7020				
28	1312														
		1372	1904	2436	2968	3500	4228	4928	5404	6272	7560				
30	1404														
		1470	2040	2610	3180	3750	4530	5280	5790	6720	8100				
32	1496														
		1568	2176	2784	3392	4000	4832	5632	6176						
34	1588														
		1666	2312	2958	3604	4250	5134	5984	6562						
36	1680														
		1764	2448	3132	3816	4500	5436	6336	6948						
38	1772														
		1862	2584	3306	4028	4750	5738	6688	7334						
40	1864														
		1960	2720	3480	4240	5000	6040	7040	7720						
42	1956														
		2058	2856	3654	4452	5250	6342								
44	2048														
		2156	2992	3828	4664	5500	6644								
46	2140														
		2254	3128	4002	4876	5750	6946								
48	2232														
		2352	3264	4176	5088	6000	7248								
50	2324														
		2450	3400	4350	5300	6250	7550								
52	2416														
		2548	3536	4524	5512	6500									
54	2508														
		2646	3672	4698	5724	6750									
56	2600														
		2744	3808	4872	5936	7000									
58	2692														
		2842	3944	5046	6148	7250									
60	2784														
		2940	4080	5220	6360	7500									
62	2876														
		3038	4216	5394	6572	7750									
64	2968														
		3136	4352	5568	6784	8000									
66	3060														
		3234	4488	5742	6996	8250									
68	3152														
		3332	4624	5916	7208	8500									
70	3244														
		3430	4760	6090	7420	8750									



Standaard inbegrepen:
Muurbeugel en muurconsole

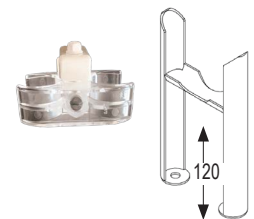

Optioneel: Afstandhouder en
stalen ondervoetje

DRL MULTICOLOM radiatoren worden af fabriek geleverd in blokken van max. 40 elementen. Indien u bij bestelling van radiatoren langer dan 40 elementen niets aangeeft, koppelen wij de blokken kosteloos (dus de radiator in 1 stuk). U dient er rekening mee te houden dat op de plaats waar de radiatoren gekoppeld zijn, de pakkingring altijd zichtbaar zal blijven.

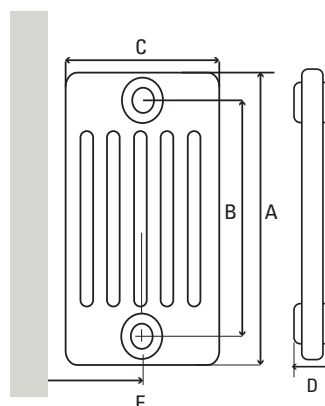

DRL MULTICOLOM 6 KOLOMS

MODEL	A (mm)	B (mm)	C (mm)	D (mm)	E (mm)	Gewicht (kg)	Inhoud (l)
207	207	151	230	46	155-175	1,07	0,80
300	300	244	230	46	155-175	1,49	1,10
400	400	344	230	46	155-175	1,92	1,30
500	500	444	230	46	155-175	2,34	1,60
600	600	544	230	46	155-175	2,76	1,80
750	750	694	230	46	155-175	3,4	2,20
900	900	844	230	46	155-175	4,03	2,50
1000	1000	944	230	46	155-175	4,46	2,80
1200	1200	1144	230	46	155-175	5,30	3,20
1500	1500	1444	230	46	155-175	6,57	4,00
1800	1800	1744	230	46	155-175	7,84	4,70
2000	2000	1944	230	46	155-175	8,69	5,20
2200	2200	2144	230	46	155-175	9,53	5,60
2500	2500	2444	230	46	155-175	10,80	6,40

DRL MULTICOLOM COMFORT 4-5-6 KOLOMS

KOLOM RADIATOR

DRL ART.NR.	HOOGTE H (mm)	LENGTE L (mm)	AANTAL ELEMENTEN (mm)	DIEPTE (mm)	H.O.H. AANSLUITING (mm)	A (mm)	B (mm)	C (mm)	GEWICHT (kg)	WATER INHOUD (Lt)	AFGIFTE 75/65/20	
											(Watt)	kcal/h*
369001	350	650	4	290	444	184	500	350	28	6,4	424	365
369002		806			600	184	656	506	32	7,6	536	461
369003		1006			800	184	856	706	38	9,6	676	581
369004		1350			1144	184	1200	1050	45	13,0	900	744
369005		1650			1444	184	1500	1350	53	15,8	1080	929
369006		1950			1744	184	1800	1650	62	18,7	1252	1077
369007		2150			1944	184	2000	1850	71	20,7	1360	1170
369008		2350			2144	184	2200	2050	77	22,6	1464	1259
369009		2650			2444	184	2500	2350	86	25,5	1612	1386
369011	396	650	5	290	444	230	500	350	31	8,0	530	456
369012		806			600	230	656	506	36	9,5	670	576
369013		1006			800	230	856	706	43	12,0	845	727
369014		1350			1144	230	1200	1050	51	16,2	1125	968
369015		1650			1444	230	1500	1350	61	19,8	1350	1161
369016		1950			1744	230	1800	1650	70	23,4	1565	1346
369017		2150			1944	230	2000	1850	81	25,8	1770	1462
369018		2350			2144	230	2200	2050	88	28,2	1830	1574
369019		2650			2444	230	2500	2350	98	31,8	2015	1733
369021	442	650	6	290	444	276	500	350	34	9,6	636	547
369022		806			600	276	656	506	40	11,4	804	691
369023		1006			800	276	856	706	48	14,4	1014	872
369024		1350			1144	276	1200	1050	57	19,4	1350	1161
369025		1650			1444	276	1500	1350	68	23,8	1620	1393
369026		1950			1744	276	1800	1650	79	28,1	1878	1615
369027		2150			1944	276	2000	1850	91	31,0	2040	1754
369028		2350			2144	276	2200	2050	98	33,9	2196	1889
369029		2650			2444	276	2500	2350	109	38,2	24518	2079

STANDAARD AANSLUITINGEN 13 EN 14

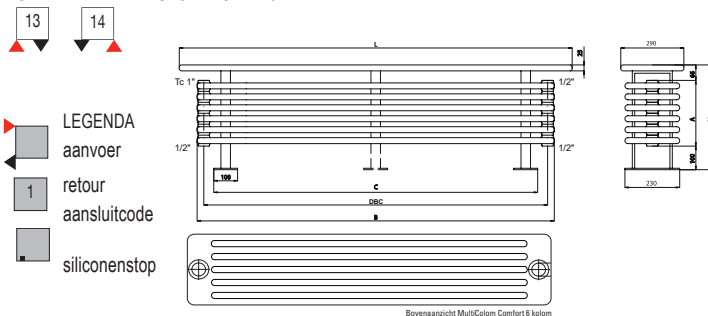

SPECIFICATIES:

- Materiaal:** Buizen in gepoedercoat staal ϕ 25 mm
Zitting van massief hout 25 mm
- Afgifte:** In Watt bij 75/65/20 | Conform EN 442
- Werkdruk:** Afgeperst op 10,5 bar. Maximale werkdruk van 8 bar bij 95°C.
- Vermogens:** Tussen 54 en 8750 Watt
- Aansluitingen:** STANDAARD: 13 en 14
- Kleuren:** Wit RAL 9010 of 9016
Leverbaar tegen een meerprijs in alle RAL- en diverse metaalkleuren (zie kleurenkaarten achterin)
Zitting: Massief hout
Gepoedercoat met ecologisch poeder
- Lakproces**
- Garantie:** 5 jaar fabrieksgarantie
- Selecties maken:** Met www.snelselect.nl kunt u snel en eenvoudig selecties maken, calculeren en bestelinformatie genereren voor uw groothandel

KENMERKEN MULTICOLOM COMFORT

- Hoogte maten (A) 350, 650, 396 en 442 mm, 4 t/m 6 elementen
- Lengte maten 650, 806, 1006, 1350, 1650, 1950, 2150, 2350 en 2650 mm
- Diepte: 290 mm
- Hoge warmte afgifte dus uitermate geschikt voor lage temperatuurinstallaties
- Door grote oppervlakte straalt de kolomradiator veel warmte uit
- Duurzaam en energiebesparend
- Zeer lange levensduur dankzij hoge kwaliteit
- Gemakkelijk schoon te houden



DRL MULTICOLOM STALEN ONDERZETVOETJES

DRL ART.NR.	OMSCHRIJVING	CODE
903052	MultiColom stalen onderzetvoetje 2 koloms 120 mm hoog RAL9010 incl. muurbeugel	C01
903053	MultiColom stalen onderzetvoetje 3 koloms 120 mm hoog RAL9010 incl. muurbeugel	C01
903054	MultiColom stalen onderzetvoetje 4 koloms 120 mm hoog RAL9010 incl. muurbeugel	C01
903055	MultiColom stalen onderzetvoetje 5 koloms 120 mm hoog RAL9010 incl. muurbeugel	C01
903056	MultiColom stalen onderzetvoetje 6 koloms 120 mm hoog RAL9010 incl. muurbeugel	C01



Optioneel:
Muurbeugel en stalen onderzetvoetje



MultiColom
Rough Black | met
stalen ondervoetjes

Reinigingsvoorschriften

Het onderhoud en reinigen van gelakte radiatoren mag uitsluitend geschieden door stof en vuil af te nemen met een vochtige doek zonder gebruikmaking van chemische en/of schuurmiddelen.

Het reinigen of polijsten van radiatoren uitgevoerd in Chroom dient men uit te voeren met het poetsmiddel van het fabricaat Belgom.



Textiel drogen

Radiatoren zijn niet bedoeld om nat textiel te drogen.

Ventilatie

Ventilatie van de gebruikersruimte:

De ruimte waarin de (badkamer)radiator is geplaatst dient te zijn uitgerust met voldoende ventilatie zoals beschreven in het bouw besluit Artikel 3.29. Luchtverversing verblijfsgebied, verblijfsruimte, toiletruimte en badruimte.

Bij onvoldoende ventilatie kan corrosievorming aan de radiator optreden.

Vocht/condensvorming

Radiatoren in het algemeen zijn niet gemaakt om nat te worden, dan wel in aanraking te komen met zeepresten en/of schoonmaak producten.

De radiator mag niet in aanraking komen met (spat)water.

Overmatige condensvorming in de badkamer als gevolg van onvoldoende ventilatie kan leiden tot roestvorming op de radiator. Wanneer radiatoren onverhoopt toch nat worden dan dient het vocht eenvoudig met een droge doek te worden weggenomen.

Plaatsing van een elektrische radiator

Een elektrische radiator moet worden geplaatst conform de eisen die worden beschreven in de NEN 1010.

De radiator mag niet in aanraking komen met (spat)water, zeepresten of overmatige dampontwikkeling

Plaatsing van een CV- gevoede radiator

Een CV- gevoede radiator moet horizontaal gemeten op minimaal 1,30m afstand worden geplaatst van een douchekop of kraan indien er geen afscheiding is tussen de douchekop of kraan en de radiator.

Daarnaast moet de radiator dusdanig worden geplaatst zodat deze niet in aanraking kan komen met (spat)water, zeepresten of overmatige dampontwikkeling.

Structuur



Rough Black



Rough Black Gold



Rough White Silver

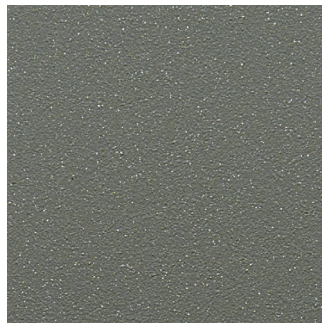

Rough Light Grey Silver

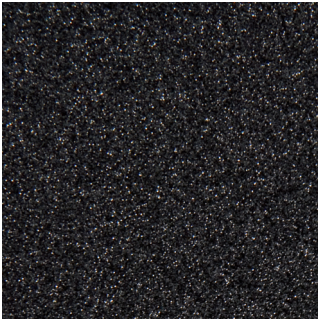

Rough Black Silver



Rough Dark Grey Silver

Polish



Polish Silver



Polish Dark Silver











Polish Aluminium Silver



Polish Dark Grey Silver

NB: Deze DRL kleurenkaart is slechts indicatief. Het is helaas niet mogelijk de werkelijke kleuren 100% nauwkeurig weer te geven. DRL-RAL kleurenwaaier en DRL metaalkleuren kaart netto excl. btw €10,- per stuk.

 1000	 1001	 1002	 1003	 1004
 1013	 1014	 1015	 1016	 1017
 1024	 1026	 1027	 1028	 1032
 2003	 2004	 2005	 2007	 2008
 3001	 3002	 3003	 3004	 3005
 3014	 3015	 3016	 3017	 3018
 3031	 4001	 4002	 4003	 4004
 4010	 5000	 5001	 5002	 5003
 5010	 5011	 5012	 5013	 5014
 5021	 5022	 5023	 5024	 6000
 6006	 6007	 6008	 6009	 6010
 6016	 6017	 6018	 6019	 6020
 6027	 6028	 6029	 6032	 6033
 7004	 7005	 7006	 7008	 7009
 7016	 7021	 7022	 7023	 7024
 7034	 7035	 7036	 7037	 7038
 7045	 7046	 7047	 8000	 8001
 8011	 8012	 8014	 8015	 8016
 8025	 8028	 9001	 9002	 9003
 9011	 9016	 9017	 9018	 pergamon

 1005	 1006	 1007	 1011	 1012
 1018	 1019	 1020	 1021	 1023
 1033	 1034	 2000	 2001	 2002
 2009	 2010	 2011	 2012	 3000
 3007	 3009	 3011	 3012	 3013
 3020	 3022	 3024	 3026	 3027
 4005	 4006	 4007	 4008	 4009
 5004	 5005	 5007	 5008	 5009
 5015	 5017	 5018	 5019	 5020
 6001	 6002	 6003	 6004	 6005
 6011	 6012	 6013	 6014	 6015
 6021	 6022	 6024	 6025	 6026
 6034	 7000	 7001	 7002	 7003
 7010	 7011	 7012	 7013	 7015
 7026	 7030	 7031	 7032	 7033
 7039	 7040	 7042	 7043	 7044
 8002	 8003	 8004	 8007	 8008
 8017	 8019	 8022	 8023	 8024
 9004	 9005	 9005 Mat Zwart	 9006	 9007
				 9010

NB: Deze DRL kleurenkaart is slechts indicatief. Het is helaas niet mogelijk de werkelijke kleuren 100% nauwkeurig weer te geven. DRL-RAL kleurenwaaier en DRL metaalkleuren kaart netto excl. btw € 10,- per stuk.

De juiste radiator in EEN PAAR STAPPEN

Ga naar www.snelselect.nl, het handige selectieprogramma van DRL Products met het totaal overzicht van alle DRL radiatoren en accessoires, inclusief alle mogelijke kleuren, aansluitingen, afmetingen en bijbehorende prijzen. Maak hiermee eenvoudig de gewenste selectie van jouw badkamer- of keukenradiator in een paar klikken:

WWW.SNELSELECT.NL 

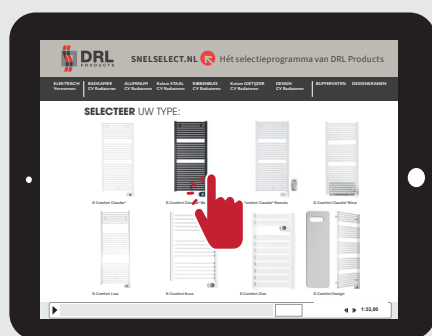

BEKIJK SNELSELECT.NL
INSTRUCTIEFILM



1. Selecteer de gewenste product GROEP
2. Selecteer TYPE radiator, kleur en accessoires
3. Calculeer en genereer de bestelinformatie voor de groothandel